

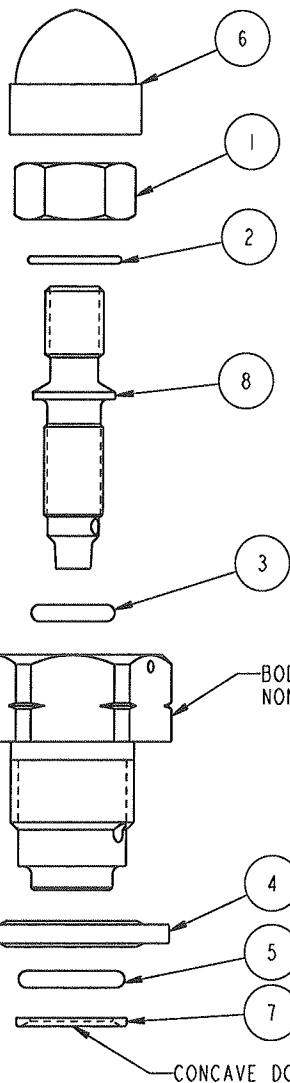

1			2	
MODEL NO.			MODEL NAME	
47020373			ASSY, FLOW CONTROL, G1/4, 14.22	
NO.	QTY	PART NO.	DESCRIPTION	SEAL KIT
1	1	21420020	NUT, HEX, 1/4-28, NYLON	NO
2	1	23002019	RETAINING RING, ROUND, INTL, 9mm	NO
3	1	39000077	O-RING, (-009), .208x.070, 90 AU	YES
4	1	39050005	SEAL, BONDED, 1/4 BSPP	YES
5	1	39050042	O-RING, (-011), .301x.070, 90 AU	YES
6	1	68050004	CAP, DOME, HEX, 1/4	NO
7	1	87000042	SPACER, FLOW CONTROL, G1/4	NO
8	1	97020001	ASSY, NEEDLE & STEM, SAE4 / G1/4	NO
N/A	N/A	60701609	KIT, SEAL, FLOW CONTROL, G1/4	NOTED



THIS IS A TWO PAGE PARTS LIST.
 THIS FIRST PAGE APPLIES TO
 MODEL NO. 47-0203-73 REVISION "D"
 AND LATER REVISIONS.
 THE SECOND PAGE APPLIES TO REVISION "C"
 AND EARLIER REVISIONS.



- NOTES:
 1. APPLY LUBRICANT TO ALL SEALS
 PRIOR TO INSTALLATION.
 2. DO NOT USE SILICONE TYPE LUBRICANTS.

PARTS LIST	 VEKTEK, INC. 1334 E. SIXTH AVE. P.O. BOX 625 EMPORIA, KS. 66801 U.S.A.	
	ASSEMBLIES AFFECTED 47-0203-73	PARTS LIST, ASSY, FLOW CONTROL, G1/4, 14.22 *****
SIZE A	MPLV7002	REV C

C	2302	RELEASE	K. ROEMER	07/29/11
REV	IN ACCORDANCE WITH ECN	EFFECTIVE DATE	REVISED BY	DATE
DRW BY:	DRAWING STATUS: Released			
DATE: 06/30/08	PRODUCTION APPROVED FOR RELEASED STATUS ONLY			

SHEET 1 OF 1

1 2

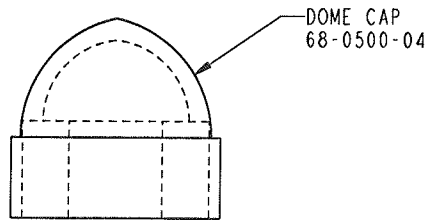

DOME CAP
68-0500-04



NUT
21-4200-17

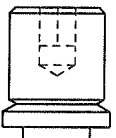

NEEDLE STEM
NON REPLACEMENT PART

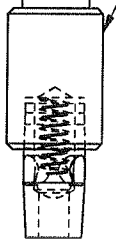

* BACK UP RING
39-0540-30

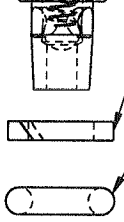

* O-RING
39-0000-53

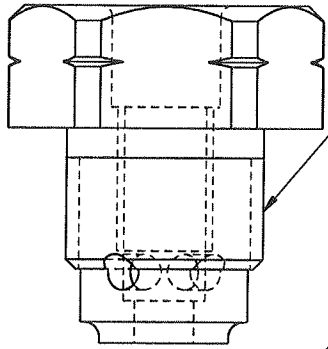

BODY
NON REPLACEMENT PART

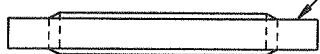

* BONDED SEAL
39-0500-05



* O-RING
39-0510-25

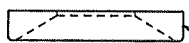

DIFFUSER
87-0000-17

* INCLUDED IN SEAL KIT 60-7016-05

PARTS LIST		
	VEKTEK, INC. 1334 E. SIXTH AVE. P.O. BOX 625 EMPORIA, KS. 66801 U.S.A.	
ASSEMBLIES AFFECTED 47-0203-73	PARTS LIST, ASSY, FLOW CONTROL, G1/4 *****	
SIZE A	MPLV7002	REV B

B	1983	RELEASED	GLR	12/19/08
REV	IN ACCORDANCE WITH ECH	EFFECTIVE DATE	REVISED BY	DATE
DRW BY:	GAV	DRAWING STATUS: Released PRODUCTION APPROVED FOR RELEASED STATUS ONLY		
DATE:	6/30/08			

1 2 FORM FEG035.PL.ASIZE, REV. A

B

B

A

A

SHEET 1 OF 1